

**META META SLIM Mitigeur monocommande de lavabo avec garniture
d'écoulement - Bronze brossé**







META

33 501 662



- saillie 125 mm
- bec déverseur fixe
- jet circulaire enrichi en air
- hauteur de robinetterie 134 mm
- hauteur jusqu'au mousseur 52 mm
- diamètre de percement 35 mm
- 2x flexible de pression M 8 x 1 vissé, étanchéité contrôlée
- débit maxi. 5,7 l/min
- sans plomb
- Ce produit contribue au respect des exigences des systèmes d'évaluation des bâtiments écologiques, par exemple LEED®, BREEAM®, DGNB

Convient uniquement à un lavabo avec trop-plein.

	Bronze brossé	33 501 662-42
	Chrome	33 501 662-00
	Platine brossé	33 501 662-06
	Platine	33 501 662-08
	Dark Chrome	33 501 662-19
	Or clair	33 501 662-26
	Or clair brossé	33 501 662-27
	Laiton brossé (Or 23cts)	33 501 662-28
	Rouge	33 501 662-29
	Orange	33 501 662-30
	Vert foncé	33 501 662-31
	Noir mat	33 501 662-33
	Champagne brossé (Or 22cts)	33 501 662-46
	Champagne (Or 22cts)	33 501 662-47
	Chrome brossé	33 501 662-93
	Dark Platinum brossé	33 501 662-99

META META SLIM Mitigeur monocommande de lavabo avec garniture d'écoulement - Bronze brossé

META

33 501 662
mm [inches]



Diagramme de débit



META META SLIM Mitigeur monocommande de lavabo avec garniture
d'écoulement - Bronze brossé

META

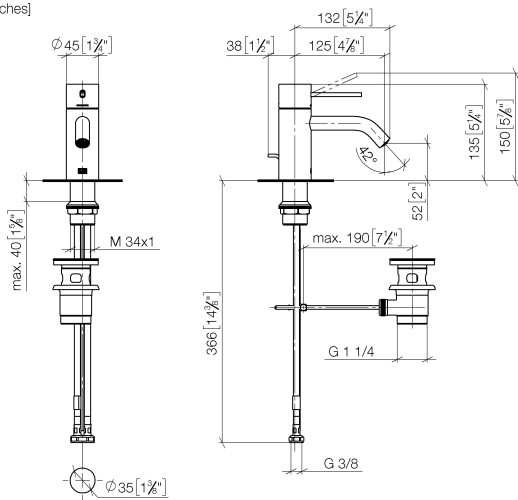
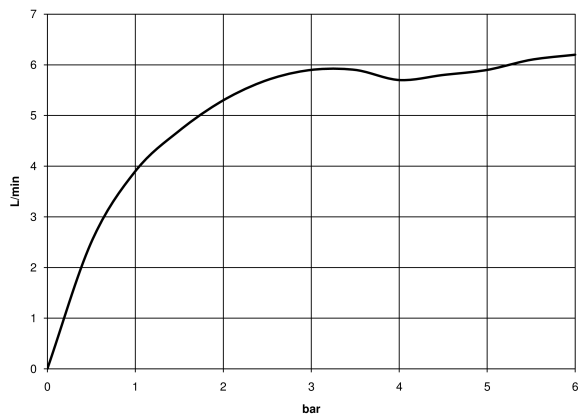
33 501 662

Les pièces pour les
autres finitions
peuvent être
trouvées ici : [Chrome](#)

